

# Habitat 44°

## The Art of Reconstruction

by

Marcus A. Gordon

a thesis exhibition presented to OCAD University

in partial fulfillment of the requirements

for the degree of

Master of Fine Arts

in

Digital Futures

April 2017

Black Box Lab, April 13<sup>th</sup>-18<sup>th</sup>, 2017

Toronto, Ontario, Canada, April, 2017

© Marcus A. Gordon 2017

## AUTHOR'S DECLARATION

I hereby declare that I am the sole author of this thesis. This is a true copy of the thesis, including any required final revisions, as accepted by my examiners.

I authorize OCAD University to lend this thesis to other institutions or individuals for the purpose of scholarly research.

I understand that my thesis may be made electronically available to the public.

I further authorize OCAD University to reproduce this thesis by photocopying or by other means, in total or in part, at the request of other institutions or individuals for the purpose of scholarly research.

Signature: \_\_\_\_\_

“Holography-based techniques will open up new possibilities in the visualization domain, allowing new visual worlds. In the meantime, holography can be a useful technical and theoretical tool for reflecting on how our everyday mediascape works.”

Pier Luigi Capucci in *The case of holography among Media Studies, art and science*.

(Capucci, 2011)

# ABSTRACT

*Habitat 44° - The Art of Reconstruction*

Marcus A. Gordon

Master of Fine Arts in Digital Futures, 2017

OCAD University

With my thesis project, Habitat 44°, I investigate the complexity of *holographic space* and how holography has the potential to augment the observers' view of their surrounding environment. The purpose of this research is to isolate unique characteristics of architecture and holography to lay the foundation for my art practice. In the field of holography, both artists and scientists alike refer to the holographic image as a "reconstruction," a shorthand for *wavefront* reconstruction. At the intersection of holography and architecture, I explore the critical implications of my reconstructions through the lens of Jens Schröter and his analysis of the transplane image, and through Rosalind Krauss' concept of *axiomatic structures*. Taking a constructivist approach, I create a holographic artwork and fabricate a *spatial canvas* that acts as an intervention in architectural space in order to construct a theory and practice of *environmental holography*.

**Keywords:** Holography, architecture, physical, virtual, space, abstraction, quasi-architecture, reconstruction, transparent material, models, transplane, pavilion, digital architecture, constructivist, environmental art, transmission hologram, augmented reality, wave optics, material energy, virtual optics.

## ACKNOWLEDGEMENTS

This thesis research is indebted to the outstanding advisory of my committee led by Martha Ladly, Philippe Blanchard, and my technical advisor and mentor Michael Page. I have been fortunate to have worked with these powerhouses of the university and know that their invaluable advice will continue to positively impact the creativity and professionalism of my practice.

I would like to record a voice of thanks to the many at OCAD U who have been a large influence and a source of inspiration throughout my graduate study, including Anda Kubis who has given me the opportunity to exhibit my first public artwork at the university. I owe a tremendous amount of gratitude to Natalie Logan, STM Holographic and the OCAD U PHASE Lab for their support in making my transition into the field of holography an exciting journey into the future.

To my family, mother, father, my three sisters and close friends for putting up with my late nights, long talks and my sporadic disappearances. Thank you for your support these past two years.

A big thank you to Charles Pachter for your financial support and to the Visual Analytics Lab for your employment opportunity throughout my studies.

## DEDICATION

I dedicate this to all artists who use science and developing technologies in their work.

# TABLE OF CONTENTS

|   |      |
|---|------|
| AUTHOR'S DECLARATION                        | ii   |
| ABSTRACT                                    | iv   |
| ACKNOWLEDGEMENTS                            | v    |
| DEDICATION                                  | vi   |
| LIST OF FIGURES                             | viii |
| INTRODUCTION                                | 1    |
| Research Questions                          | 2    |
| Scope and Limitations                       | 4    |
| Significance of the Project                 | 4    |
| LITERATURE REVIEW                           | 8    |
| THEORETICAL FRAMEWORK                       | 14   |
| Duality of Spaces                           | 14   |
| Architecture vs Not-Architecture            | 17   |
| CONSTRUCTIVIST ART METHODOLOGY              | 21   |
| EXHIBIT                                     | 25   |
| The Pavilion Experiment                     | 25   |
| The Spatial Canvas Experiment               | 33   |
| EXHIBIT PLATES                              | 39   |
| CONCLUSION & FUTURE DIRECTIONS              | 42   |
| The Art of Reconstruction                   | 42   |
| Future Directions: Augmented Reality        | 44   |
| Future Directions: Material Energy of Light | 45   |
| REFERENCES                                  | 46   |
| APPENDIX A: GLOSSARY                        | 48   |
| APPENDIX B: HOLOGRAPHY SPECIFICATIONS       | 51   |
| APPENDIX C: DIGITAL SKETCHES & DRAWINGS     | 53   |



## LIST OF FIGURES

|   |    |
|---|----|
| Fig. 1. To Absent Friends hologram by Paula Dawson. Reprinted with permission.                          | 10 |
| Fig. 2. [Lateral View] Photo of Holomentis by Marcus A. Gordon.   | 14 |
| Fig. 3. [Frontal View] Photo of Holomentis by Marcus A. Gordon.   | 15 |
| Fig. 4. Diagram of Holographic Space (Pepper, 1989)   | 16 |
| Fig. 5. Sculpture in the Expanded Field Diagram (Krauss, 1979)  | 17 |
| Fig. 6. A remix of Krauss' axiomatic structures region from her diagram on sculpture.                   | 18 |
| Fig. 7. [Frontal View] Habitat 44° pavilion digital sketch  | 24 |
| Fig. 8. Photo of acrylic sculpture by Marcus A. Gordon.   | 26 |
| Fig. 9. Photo of bokeh effect showing in the illumination of the first maquette by Marcus A. Gordon.    | 31 |
| Fig. 10. Photo of optical table setup for the first maquette by Marcus A. Gordon.                       | 31 |
| Fig. 11. Photo of the illumination of the second maquette by Marcus A. Gordon.                          | 32 |
| Fig. 12. Photo of the illumination of glass holographic optical elements blocks by Marcus A. Gordon.    | 36 |
| Plate. A. Photo of suspended architectural maquette by Marcus A. Gordon.                                | 39 |
| Plate. B. Photo of suspended hologram of architectural maquette by Marcus A. Gordon.                    | 39 |
| Plate. C. Photo of both exhibited holograms perceived as one virtual image by Marcus A. Gordon.         | 40 |
| Diagram. B1. Diagram of optical table setup for the Advanced Prototype by Marcus A. Gordon.             | 51 |
| Diagram. B2. Diagram of optical table setup for the recording of the Spatial Canvas by Marcus A. Gordon | 52 |
| Sketch. C1. Building blocks of the Experimental Prototype by Marcus A. Gordon.                          | 53 |
| Sketch. C2. Original model of Habitat 44° pavilion concept by Marcus A. Gordon.                         | 53 |
| Sketch. C3. Digital sketch of architectural maquette by Marcus A. Gordon.                               | 54 |
| Sketch. C4. Measurements sketch for maquette windows by Marcus A. Gordon.                               | 54 |
| Sketch. C5. Habitat 44° pavilion concept with geodesic dome by Marcus A. Gordon.                        | 55 |



## INTRODUCTION

*"We are surrounded by flat representations of the three-dimensional world."* (Pepper, 1989)

There is more to the experience of the third dimension that surpasses the limitations and boundaries of a linear perspective; something that cannot be explained by a photograph or a flat illustration in a book. It is this curiosity that has propelled holographers, virtual reality artists, and architects to seek out new approaches. What can we learn from architects as creators of the concrete, mass material and the structures that surround our everyday? One would typically say that raw and processed materials are the tangible building blocks of their profession, but that thinking continues to change.

"Architecture has always involved, as an integral part of its creative process, the production of abstract spaces from which concretizable forms are drawn" (Massumi, 1998). We see this with the advent of digital architecture<sup>1</sup>, this now being a standard form of design process in architectural practice. Massumi's quote, however, speaks to abstraction, and the digital realm is not the only influential medium of abstract space. Holographers, seeking this same abstraction in other terms, leave a trail of possibility for the field of architecture. In fact, both fields share a major commonality: light.

"[Architecture's] basic medium is light. It uses concrete and stone, metal and glass, to sculpt light in ways that either direct the fixations of attention steadfastly away from their confounded conditions of emergence or on the contrary enable it sporadically to fold-back into them" (Massumi, 1998). Holography is *also* about the recording and sculpting of light. It is this intersection, of holography and architecture, that drives my research interests and the intention to create environmental holograms in architectural spaces.

Take your home, for instance, a collection of rooms with four walls, which translates to a *spatial canvas* of sorts awaiting your creative customization of the space. You paint, decorate and furnish, turning your space into one that resonates with you. Colour, design, and function guide the decisions you make in that rooms' customization. There is a sense that you become aligned with the rhythms of the room. For perspective, another example of this connection would be the feeling you get from wanting

to stop and reflect on an artwork that you come across in passing *en route* to work, school or an event. The work might be in view from the path you take, but is not in the way of you getting to your location. But yet, the artwork forces your body to stop and admire and/or question its existence to the point that it interrupts your regular flow. My intent is to create rhythmic connections as described, through *environmental holography* experiments. With the medium of holography, I argue that it can project a sense of extended physical space. I believe this occurs by witnessing *virtual* space within the structure of a physical space and seeing it as a type of enhanced architecture.

## Research Questions

The primary research question that will propel the investigation of these experiments is based on the argument that *holographic space* can *extend* physical space:

*How can the virtual image of holography contribute to the dialogue of abstraction in architecture?*

Holograms come in many forms. For my particular research, I will refer to one major type of hologram: the *transmission hologram*, that refers to the way it reconstructs an image by transmitting light *through* a photosensitive surface. Dependent on content and context, various forms of holograms speak to my argument of an extended physical space, which I define as *an experiential complex space that is perceived autostereoscopically as both physical and virtual*. The transmission hologram, however, bodes well with the concept of rear lighting like the type found in photography light boxes.

The dialogue of abstraction is key to architectural practice as referred to in Patrik Schumacher's writings on architecture and parametricism such as *The Autopoiesis of Architecture* where he highlights a central message that "architects do not build." They work with representational models, drawings and digital information structures to design their creations (Schumacher, 2011). I believe holograms such as transmission holograms and holographic optical elements are tools that can be added to the architects' list of representational modeling tools. Like architectural drawings, for instance, such assets have the distinct capacity to transcend the practice into what Schumacher also indicates as the art system (Schumacher, 2011, 5.1.7). Holography, also as a visual art practice, transcends that same space

from representation tool to form of expression. In my view, holography's strength in the *art-architecture* system is the duality of the virtual and the physical.

To clarify the distinction I make between what is physical and what is virtual, the physical here represents anything *tangible* or *concrete*. The virtual in holography refers to the image seen behind the *holographic plate*, and in computing refers to things not physically existing but created by software. When referring to the complex of *holographic space*, my other interest is in how the virtual image in holography can also contribute to the dialogue of the duality of spaces. This leads to my secondary research question:

*Can the intervention of a **spatial canvas** be grounds to a re-contextualization of the duality of spaces?*

This secondary question serves to consider the social implications of holographic artworks within the built environment. To further study this idea of extended physical space, I create a *spatial canvas* representing the window of a pavilion augmented with a holographic image. This work defines the very start of my practice of *environmental holography* as a mode of intervention into public spaces. In addition to this, I engage in a self-reflexive critical observation of the fabricated work. With the pavilion at the center of the research as an architectural structure in which holograms are combined, an exploration of architectural representations is pursued.

## Scope and Limitations

My research looks at the dualities of physical *and* virtual space and as such limits the scope to perceptual characteristics of architecture and environmental art in these spaces. The placing of work outdoors in cityscapes and landscapes is similar to the confines of an environmental art practice. The pursuits extend to both indoors and outdoors, public spheres and private spheres. However, the scope of Habitat 44° is limited to the development of holography research and specifically its impact on physical spaces. The Habitat 44° research places the spotlight on the atmospheric intervention of architectural spaces. As a potential contingency, I consider the conceptualization of these and future interventions as paper architecture, similar to the drawings and models of Constant Nieuwenhuys' New Babylon or Zaha Hadid's Malevich's Tektoniks<sup>2</sup>.

## Significance of the Project

Habitat 44° as a project name, came from a few sources of inspiration. In reflection of Habitat 67 in my home city of Montreal, Moshe Safdie's master's thesis became a visual reminder for me of the Expo 67 that I only had the ability to read about, but has had a tremendous impact on my future vision as the Expo celebrated the "future of cities". As a form of wordplay, the 44° in the name is used as an approximate latitude for where the city of Toronto is positioned on the planet and signifies a pseudo location of where the research begins. This is also known as the 44th parallel north, indicating 44 degrees from the earth's equatorial plane.

Holography is a field in existence since the mid to late 1960's and regarded as a high-technology art form, where high costs in lasers and precision optical components made it a niche market requiring specific levels of expertise. However, times have changed with the industry growth and so have the options and capabilities of the holographic printing process. With advancements in digital holography, for instance, artists capable of producing works have increased since those with 3D and *computational photography* expertise can apply their knowledge to the production of holographic art. I began my research in the field of digital holography and noticed a few things that I consider strong reasons for its potential in media history: (1) as explained in Schröter's thesis on the transplane image, there's been a historical preference for the perspectival image which derived an academic and industry

focus, over time, on the planocentric image and its visualization capabilities (Schröter, 2014). That (2) digital technology has prolonged the linear perspective view of imaging and situated preference towards three-dimensional imaging via *virtual optics* (Schröter, 2014) such as virtual reality and augmented reality<sup>3</sup> (Hockett, 2016). The significance of this track in history, could lead to a better understanding of our needs for spatial imaging and make a case for increasing research focus on *wave optics* to eventually bring today's digital visualization practices into the fore of our natural environment. Lastly, (3) the confusion surrounding nomenclature and semantics outside the field (specifically around the word "hologram" and what *constitutes* a real "hologram") has an impeding affect that fuels holographic research to go in reverse or slow down. This also creates confusion in other related fields of research where the third-dimension is concerned<sup>4</sup>.

As a final note on significance, the rationale behind the pavilion as the concrete object of the research, supports my interest in studying architectural works. It also supports the notions of social spaces and architectures of enjoyment, as pavilions historically are extensions of palaces, gardens, courts and extensions of human habitats. The history of the pavilion demonstrate patterns of transformation in its identity, its self-expression and its utility, over time. What makes it an ideal vehicle for this research I feel is due to its experimental character. Sometimes the experimentation is about its construction, the materials, site-specificity or its social impact. Habitat 44° is a study of these same characteristics of a new pavilion concept combined with the intrinsic characteristics of holography.

Contemporary pavilion architecture includes a plethora of variations and styles revealing many architectural techniques and themes such as biomimicry, parametric structure, media architecture, natural lighting materials such as bioluminescence, and techniques such as blobitecture. Including this improved catalog of building materials and features further exemplify the capacity for the pavilion to quickly and efficiently promote ephemeral art that challenges the norms of architectural space. One does not have to look any further than the structures found on the grounds of the *Serpentine Galleries* in London, the *Common Pavilions of the Venice Biennale* and the pavilions from *Expo 1967* in Montreal to the *1929 International Exposition* in Barcelona to see the generational change and outlook on spaces created by these neo-monuments.

## Notes

---

<sup>1</sup> "Digital architecture is a series of representations of an ideated physical space...and is a metaphor for the creation of spaces in cyberspace..." and/or "...a meaning for the creation of spaces for human interaction. Digital architecture is not solid or physically three-dimensional..." (Bertol, 1997)

<sup>2</sup> Constant's drawings and models represented in the book *hyper-architecture of desire* (Wigley, 1998) and Zaha Hadid's AA thesis paintings titled *Malevich's Tektonik* <http://www.zaha-hadid.com/architecture/malevichs-tektonik/>.

<sup>3</sup> Such as Oculus Rift, Microsoft Hololens, Google Glass, Google Cardboard, and others. (Hockett, 2016)

<sup>4</sup> Confusions include Pepper's Ghost, augmented reality, and volumetric displays, being thought of as "holograms" which in fact, they are not actual recordings of interference patterns which is what holograms are. For these sometimes confused technologies and techniques, I coined the term "**fauxlography**" to refer to these when mistaken for holograms. First public revelation of the term was presented by Michael Page at the International Symposium for Display Holography of 2015 in St. Petersburg, Russia.





"...new is made comfortable by being made familiar."

Rosalind Krauss in *Sculpture in the Expanded Field* (Krauss, 1979)

## LITERATURE REVIEW

### The Transplane

To take holography's history one step further (back in time, that is) the foundation of this field can be said to originate from research into the four groups of optical knowledge (geometric optics, physiological optics, *wave optics*, *virtual optics*); more specifically *wave optics* (Schröter, 2014). In *3D: History, Theory and Aesthetics of the Transplane Image* by Jens Schröter, the transplane refers to stereoscopy, photo-sculpture, integral photography, lenticular images, holography; images that provide more information on space or spatial structures of objects (Schröter, 2014). For holography, the concept of the transplane represents its aesthetic and critical origins contextualized through the history of the stereoscopic image. From this view, I position my research on holographic works as a real and expressive medium; and a well suited interdisciplinary field of study that can contribute to the criticality of art in architecture.

In Schröter's thesis, he claims that perspectival projection images create a fundamental problem in identifying such things as material form, measure, and other valuable visualization assessments and needs (Schröter, 2014). Although the photograph can provide a certain level of information, it lacks in parallel projection with its focusing of light, doing away with proper displaying of shadows, peaks and valleys, and as perspectival projection, it is not *isomorphic* (Schröter, 2014). This is one of the rationales behind Schröter's case for the transplane image and brings about a dialogue to focus our attention on a new definition of 'image', one that includes the nature of the three-dimensional image that contains spatial information. My interest in situating this fact as the basis for my thesis directs the attention towards the dialogue of space, both physical and virtual, as grounds for recontextualizing the duality of these spaces in modernity.

Schröter exemplifies the importance of visual representations of space through its reflection of 'time' and pictorial representation (linear perspective) as a contributor to the creation of spatial knowledge (Schröter, 2014). This suggests that even with the presence of the transplane image, the linear perspectival image can assist in the creation of spatial knowledge, for instance, through the advantage of the time to visualize an object or scene.

In his book, Schröter speaks to a differentiation he makes between the transplane image and the “spatial image,” the latter which he equates to sculpture, “...the comprehensive category comprising both transplane images and those that have a three-dimensional material support” (Schröter, 2014).

## A History of the Hologram

In 1947, Hungarian scientist Dennis Gabor invented holography, as most would say, as Gabor was the first to describe the principles of the technique of holography. This was eventually published in 1948, the same year Parker and Wallis published their first essay on the volumetric display (Schröter, 2014). It was a time where scientists were looking for ways to gain more information with spatial images. Both distinct endeavours; holography and the volumetric display; regardless of their unique and significant differences are both interchangeably referred to in casual conversation. Gabor’s research was interested in a particular type of spatial information; one that would improve the resolution of the electron microscope.

The term ‘hologram’ appeared in Gabor’s text in 1949, titled *Microscopy by reconstructed wave-fronts* published by the Royal Society, that traces back to the beginnings of the holographic technique. He situates this paper as a “new two-step method of optical imagery” (Gabor, 1949). ‘Hologram’ as a term was devised to differentiate between an interference pattern and a diffraction pattern, effects created in Gabor’s research experiments on improving electron *microscopy*. The key to the hologram was that the photograph (as he called it) possessed the “total information required for reconstructing the object in question, whether it be two-dimensional or three-dimensional” (Gabor, 1949).

For the purposes of this paper, a hologram will be defined as a transplane image created with *wave optics* that is a three-dimensional construct of an object. To simplify this definition, the history of the transplane image is important to understand as it is the foundation of today’s knowledge of three-dimensional imaging, including holography.

In the field of holography, the creators of holograms refer to their work as “reconstructions.” Holographic images are called this because they consist of multiple *wavefronts* of light from an

interference pattern that is “replayed” by diffracted light, as explained in Paula Dawson’s writing titled *The Visual Language of Holograms* (Dawson, 2011). Albeit a simplified description, the “replaying” is done by introducing laser light, white light or daylight to the interference pattern which creates a three-dimensional image. Similar to Dennis Gabor’s original paper on the hologram (Gabor, 1949), the replay of these *wavefronts* are a reconstruction. One of the most interesting aspects of the holographic process is that the image created can vary based on a multitude of factors including wavelength, occlusion, the scale of the object, etc. However, the most remarkable aspect of the process is the verisimilitude achieved when making the image (Pepper, 1989). A good example of this is a piece from Paula Dawson titled *To Absent Friends* where a hologram was made of a local pub (Dawson, 2011).



Fig. 1. *To Absent Friends* hologram by Paula Dawson. Reprinted with permission.

This type of work involves a certain level of precision in order to illuminate a room completely and exposed for capture by laser light. The end result is a hologram of an interior that shows great depth. These holograms of the pub created by Dawson were presented as windows in a gallery space, making this in my view, the first direct example of how holographic artworks can *extend physical space*, that is

not only obvious to the viewer but also adding to Peppers' concept of the space behind the *holographic plate* treated as a box in which to place objects (Pepper, 1989).

## Axiomatic Structures

Prior to this investigation, my interest in sculpture led me to Rosalind Krauss' essay *Sculpture in the Expanded Field* (Krauss, 1979). Initially looking at how light-based works such as holographic sculptures can be analyzed through Krauss' framework, I became drawn to the peculiarity of the *architecture* and *not-architecture* region of her diagram that which she named *axiomatic structures* (Krauss, 1979). In my view, this part of her framework applied most to the works I was creating whether it was photography, sculpture or holography. Krauss points to artists such as Robert Irwin suggesting works from the Light and Space movement would be suited in this region, this also included artists such as Bruce Nauman, Richard Serra, and Sol LeWitt, working within the realms of video, photography and other mediums (Krauss, 1979). Researching publications for a media architecture conference, I discovered *Retracing the Expanded Field*, where the conversation of the expanded field transcended sculpture to a focus on art and architecture (Krauss et al, 2014). This book of dialogues from roundtables with Julian Rose, Hal Foster, Miwon Kwon and Krauss further increased my desire to use the expanded field as a point of research and discussion surrounding experimental architecture such as pavilions. For me, pavilions are an opportunity to conceptualize architectural designs as well as sculptural work that can be defined as "*quasi-architectural*" and catalyze a critical analysis framework to situate my research of light-based artworks as interventions into architectural space. Historically, pavilions have been something of a niche type of structure, created for special occasions, as they still are today. In the essay *Introducing Pavilions*, Joel Robinson mentions that pavilions, since ancient Rome, have acquired their name from the word *papilio* in Latin meaning 'butterflies', undoubtedly referencing old temporary structures made of fabric flapping in the wind (Robinson, 2014).

## The Connection

As a mission to determine the social implications of holograms within the context of the built environment, I consider the observations of theorists on the subject of *holographic space*, beginning with Andrew Pepper and his definition of *holographic space* (Pepper, 1989). In Pepper's research, he refers to the visual paradox that explains our surprise when we encounter a hologram; a mix of our expectations of a picture within a frame, but with a three-dimensional object or scene that shows depth beyond the flat surface of that frame (Pepper, 1989). This is further explained by the nature of holograms allowing us to see items inside the box (beyond the flat surface) or outside the box (in front of the surface), seemingly between you, the viewer, and the *holographic plate*. Pier Luigi Capucci notes that holograms enhance the sensorial energy between sight and touch, essentially making us feel what we see in terms of the materiality of the represented object (Capucci, 2011). Holography provides the viewer a level of freedom that is not common to other visual media, and that is the freedom to move around an image and change your angle of view, at will, where the resulting image is different at every movement (Capucci, 2011). This differs in photography, for instance, where the three-dimensional object or scene is flattened, and every angle of view change ultimately results in the same image viewed. As such, experiencing holograms is similar to the experience of sculpture. This is my primary rationale behind the seamless integration of holographic works within physical space, at a level that they can become part of the design of future architecture. These environmental holograms signify a duality in purpose, of function, and of materiality. Similar to the ideals of the 1920s Russian Constructivist whose accordance to the material is the utmost focus of their works.

Via the concepts presented above, I synthesize that Schröter's theory of the transplane image can position holography within the continuum of media history. Krauss' expanded field presents itself as an ideal lens to observe and critically analyze this extension of architectural space.



Architecture is not simply a platform that accommodates the viewing subject. It is a viewing mechanism that produces the subject it precedes and frames its occupant.

Beatriz Colomina in *Sexuality & Space*

(Colomina, 1992)

## THEORETICAL FRAMEWORK

### Duality of Spaces

The public sphere is of particular interest to me in which to situate my light-based artworks, as well as my digital art. My first sculptural work was presented in a public space at OCAD University in Toronto, Canada, a first at integrating interdisciplinary art and research that also contributed to ongoing work in the visualization of medical information with holography. This piece is called *Holomentis*, and as a first wave of working with *holographic space*, its contextualization as a sculpture peaked my interest in combining both physical and virtual spaces.

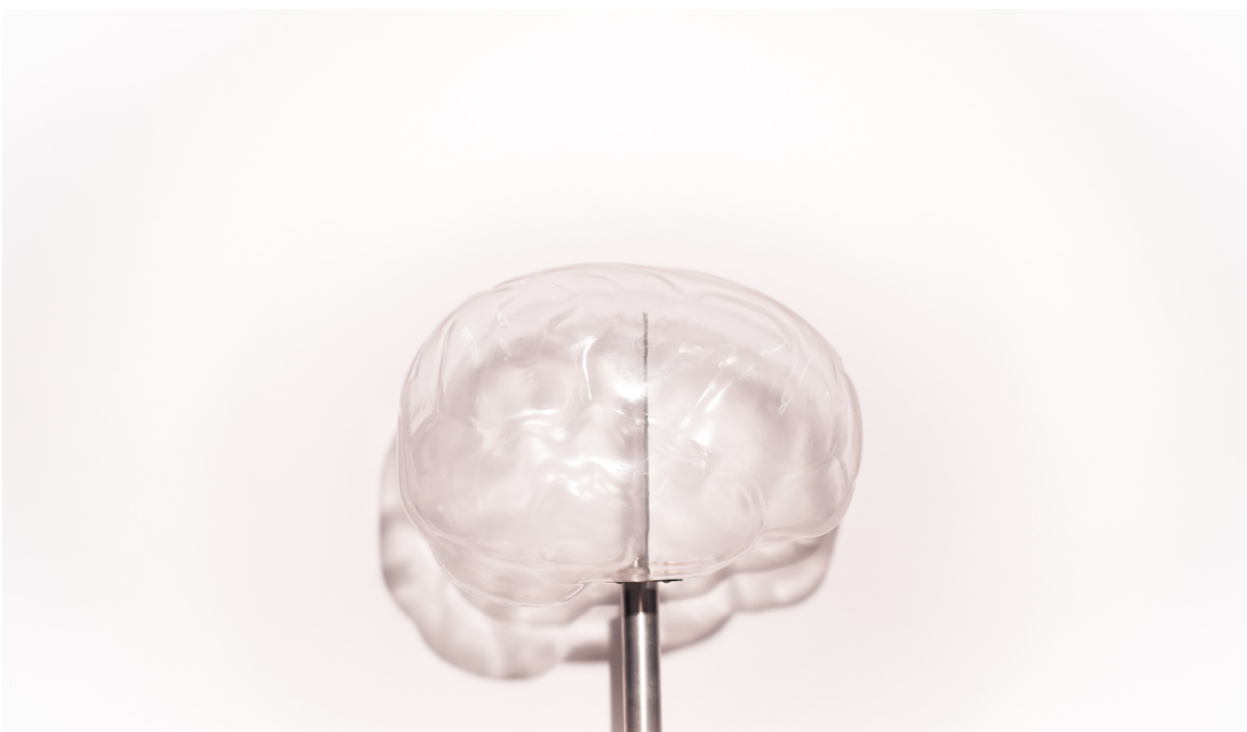

Fig. 2. [Lateral View] Photo of *Holomentis* by Marcus A. Gordon.

As a digital designer in the past, I was always fascinated with the field of digital architecture. A broad field to define, the term has been used to refer to everything from architectural visualization using computer software, to heterogeneous operations of digital form finding and parametric modeling. An expertise in itself, creating digital architectural renderings became a competent addition to traditional



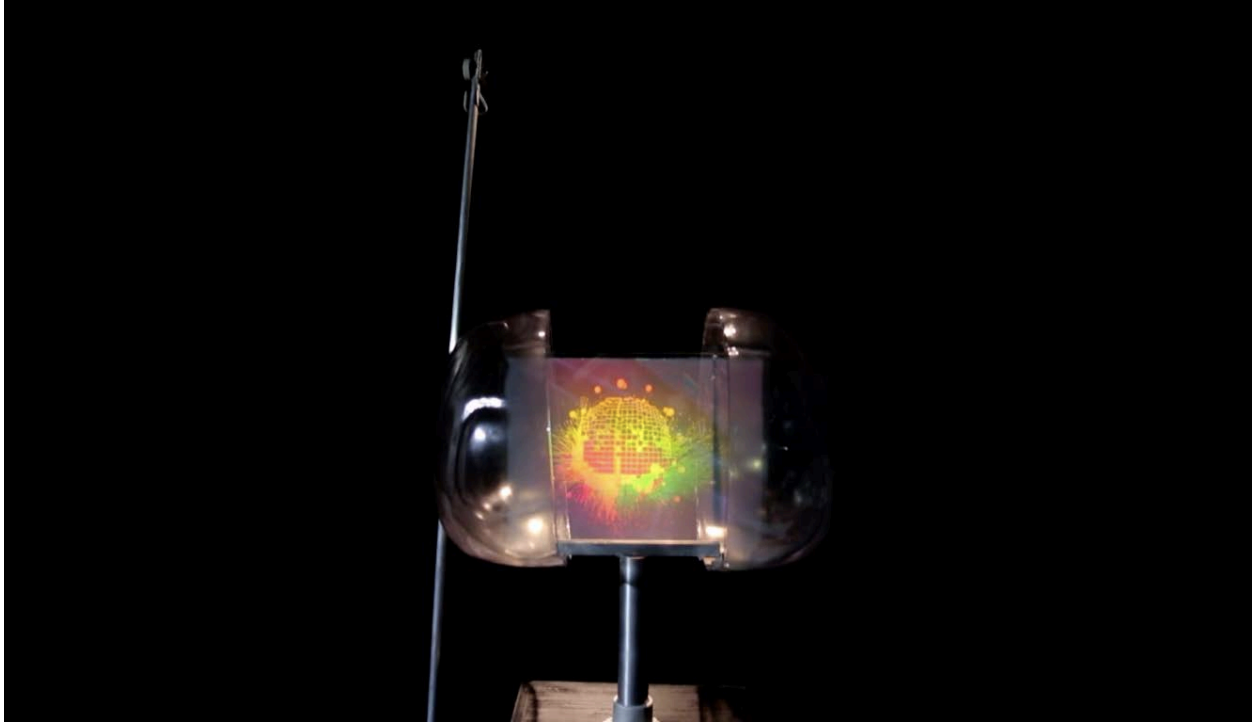

Fig. 3. [Frontal View] Photo of *Holomentis* by Marcus A. Gordon.

architectural drawing practices, but never really a replacement. However, it is this specialization that drove my interest into architecture as an adjacent field of research. As the core subject of my philosophical views on space, my interest in the field has grown significantly as I turn to architecture as a *spatial canvas* for my interventions. In the essay *Sensing the Virtual, Building the Insensible* Brian Massumi reminds us that the virtual is a form of abstraction (and not the other way around) and that it is a significant starting point in the architectural process (Massumi, 1998). This part of abstraction, the virtual, becomes a highlight and focus of the creative process in experimental architecture. Architectural models, then, are essentially an art form that lives in a “duality of spaces”, a constant cycle of experimentation and production of virtual and physical spaces.

The virtual has evolved to become less about abstraction and instead, an influential form of representation. Holography fits well within this view, as a medium that feels virtual but in many ways is a replica of reality that can have a significant level of spatial verisimilitude (Dawson, 2011). In holography, there are various spatial qualities depending on the types of holograms you create. In my initial experiments with Habitat 44°, I focus on laser light transmission holograms as well as white-light transmission holograms. Different hologram types are defined by different representation systems,

recording methods and viewing geometries. This makes for a complex level of variations that can be achieved combining these holographic image techniques with a variety of architectural styles. Although there exists a multitude of hologram types, the one that is the simplest and most capable of supporting my claim of extending spaces is the *transmission hologram*. The characteristics of this type of hologram allow for the image to be reconstructed with laser light, a spotlight or any other source of white light, such as the sun. Most importantly, the word “transmission” refers to light going “through” the glass plate to reveal the image to the viewer situated in front of the hologram. The transmission hologram allows me to install it as a window replacement, playing on the duality of spaces: the boundaries that frame the window are *physical*, and the revealed image through the glass is *virtual*.

The first window that may come to mind is the one in your home. Using Beatriz Colomina’s analogy, in the home the window acts as a view to a stage, placing the house as a metaphor for a *theater box* (Colomina, 1992). Viewing it as such would suggest that the stage could be a landscape or another open space in the house. As holography acts as a role of virtual extensibility, the form of the physical space also changes the depth perception of a hologram seen through a window in that space. Pepper refers to this as a *memory window* (Pepper, 1989). In the context of Habitat 44°, the architectural window is meant to be a vehicle for visual display in architectural spaces and to be the point of origin for the viewer to experience the depth perception of *holographic space*.

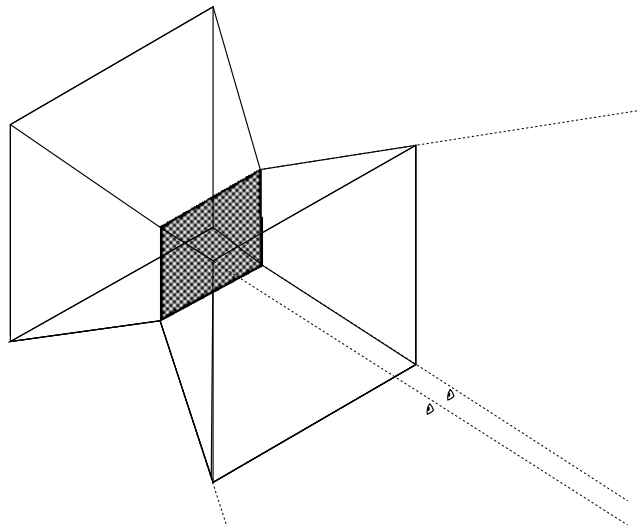

Fig. 4. Diagram of Holographic Space (Pepper, 1989)

## Architecture vs Not-Architecture

In Krauss' description of *axiomatic structures*, she indicates that a work in that region acts as a "...intervention into the real space of architecture" that can come in the form of a drawing or a partial reconstruction (Krauss, 1979).

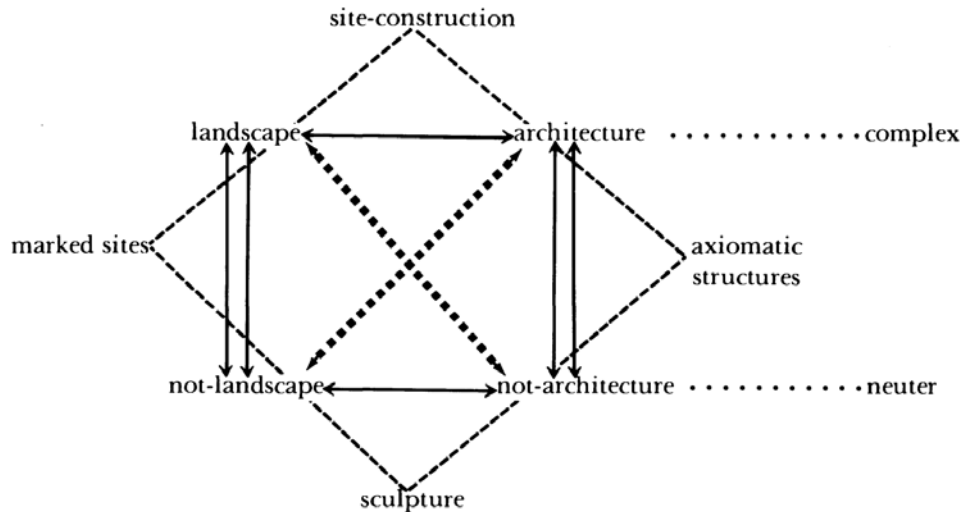

Fig. 5. Sculpture in the Expanded Field Diagram (Krauss, 1979)

In relation to Habitat 44°, axiomatic structures would identify with a light-based artwork that creates subtle atmospheric or space interventions, similar to the works of artists from the Light and Space Movement<sup>5</sup>. Also, it refers to artwork that comes in the form of architecture, specifically pavilion architecture which is the alternate subject of my research. To frame the work of Habitat 44° as axiomatic structures is to relinquish the view of the pavilion as simply a physical building, and instead, form an ongoing dialogue of experimentation within (and outside of) what constitutes architecture in the virtual sense.

As I contest that theoretical frameworks boil down to an organization of theoretical cases and variables, this thesis builds on the following two cases: (1) *holographic space* and its basis on *wave optics* being an analog form of virtuality, and (2) the *quasi-architectural*<sup>6</sup> referring to things like pavilions and architecturally influenced artworks.

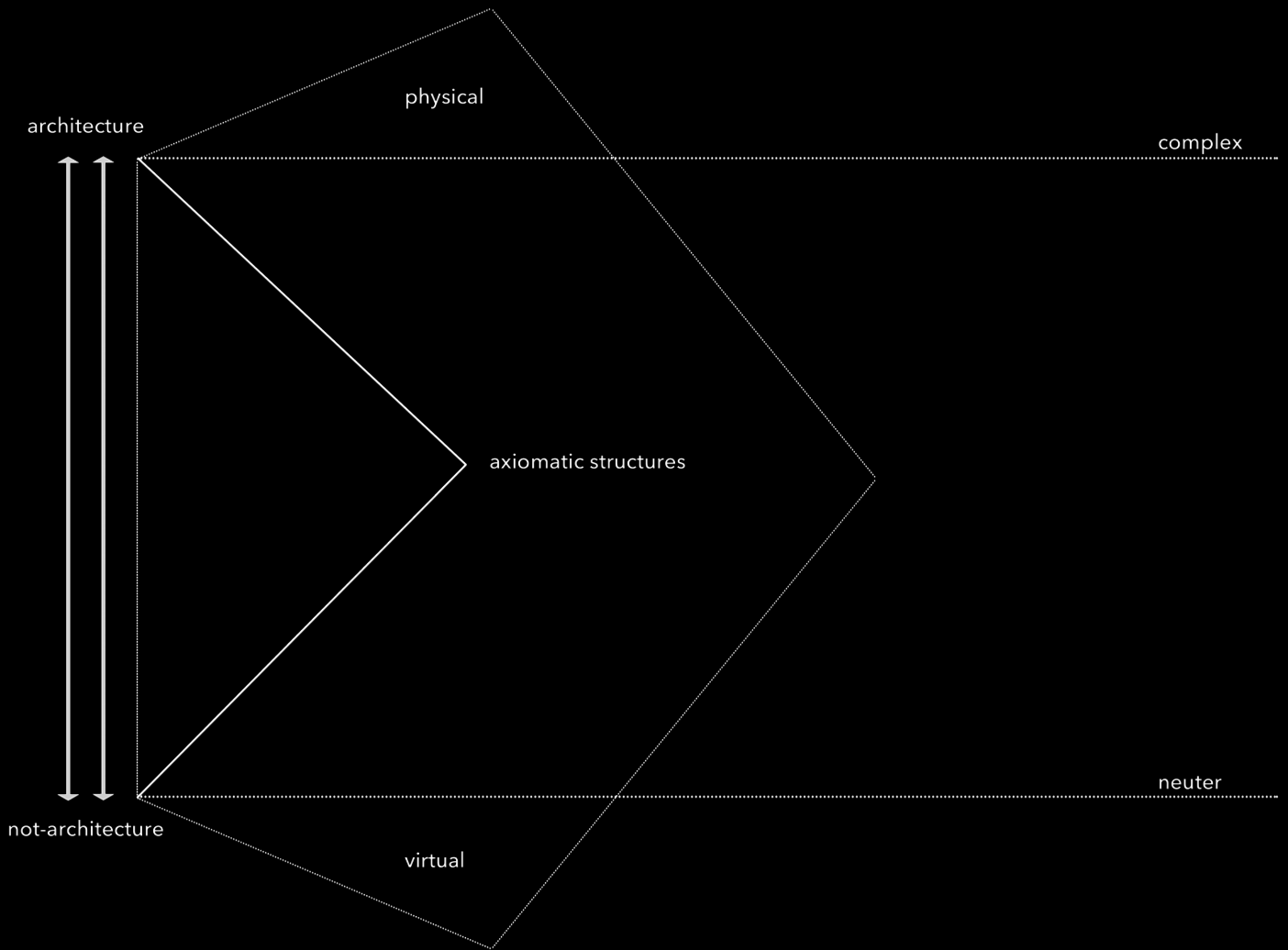

Fig. 6. A remix of Krauss' axiomatic structures and the duality of spaces by Marcus A. Gordon.

## Notes

---

<sup>5</sup> The Light and Space was an avant-garde movement that began in Southern California in the 1960s and includes light based artists such as James Turrell, Robert Irwin and Larry Bell.

<sup>6</sup> The first mention in (my research) of the term “quasi-architecture” was in Rosalind Krauss’ *Sculpture in the Expanded Field*. (Krauss, 1979)



Constructivism fosters the momentary, transitional, flexible, and  
adaptable over the monumental and eternal.

Maria Gough in *Artist as Producer: Russian constructivism in revolution*.

*(Gough, 2005)*

## CONSTRUCTIVIST ART METHODOLOGY

The Habitat 44° research project can be summarized as an experimental investigation into the making of holograms in architectural spaces. The intent is to integrate these holograms into new and existing architecture. The rationale of this thesis is based on an exploratory hypothesis of viewing holograms as a "window", that perceptively, extend physical spaces. As such, the ideation, fabrication, and exhibition of this project is experimental and seeks to add holography to traditional and contemporary architectural practice. Taking an artists' approach, a constructivist methodology is invoked as it coincides with the production characteristics of the experimental artworks in this research.

### Konstruksia Faktura Tektonika

Constructivists make works that pay respect to the nature of materials. Tatlin's view of the constructivist object is centered around the idea of *necessary form*.

*"Tatlin's 'necessary form' is a compound logic; it was to express truth to materials, mankind's authentic creative will, the universal laws of human experience, and a social necessity." (Rowell, 1978)*

Originally a painter, Tatlin began making reliefs when he visited Picasso's studio in 1913. There he experimented with wood, metal, and glass, materials often found in many (if not all) of his future reliefs. In his reliefs, for instance, *The Bottle*, the piece engages itself in the expression of each material's true nature where, wood's natural color is kept and respected, the metal reflects uniformly the light that hits its polished surface and the glass subjected to light emphasizes its invisibility (Rowell, 1978). This is what Tatlin means by the use of the term *necessary form*. The other half of what constitutes the constructivist object involves "social necessity" which refers to a diverse range of meanings including the utility or application of said object, the social implication of the object and its purpose of inspiring a new logic on the conception of art. This concept defines art as being (or directly a result of) experimentation or laboratory research (Rowell, 1978).

The constructivist object questions the external form taken from the object's primary materials. It also suggests that the purpose of the object is to also implement the original idea of the artist while making a reality its practical applications.

*The formal approach is opposed to spirituality and ideas, and the work is transformed into an experiment, a form of laboratory work. (Esche, 2007)*

This suggests the end of a spiritual basis on the creation of art, and instead places an importance on intellectual production through experimentation, submitting to the Constructivists' ideology of a "new consciousness." Varvara Stepanova systemizes the factors behind the new consciousness ideology into four points that essentially can be summarized as: (1) a call to development of industry and technology, and the creation of new inventions untied to natural forms at its inception and where its art is based on 'artificiality', (2) materialism and the concretization of artistic ideas through production, (3) the importance of craftsmanship and artificiality and the continuation of its influence on the social impact of technology, and (4) the unique classification of art practice residing outside the realm of traditional social development and aestheticism (Esche, 2007). The result of this synthesis signifies an overall switch from a spiritual focus of art to one that is derived solely from intellectual production.

These new definitions of art from the Constructivists revolve around a term frequently used in their circles known as *faktura* and is a central connection to their works describing mostly the properties and processing of organized materials in their constructions. Aleksei Gan suggested that there are three basic parts to the material elements of constructivist work: (1) **construction**, the organizing of material, (2) **faktura**, the expression of material structures (that includes the process of its creation and use), and (3) **tectonics**, "the organicity of what emerges from the inherent essence [of a given material]" (Gough, 2005).

Essentially, the three steps represent for Habitat 44° an expression of material and production technique. The properties of glass or clear acrylic play the vital role of material focus in these experiments, but also it is both metal and wood that play the role of supporting materials. They do this through the use of it to frame, connect and suspend clear glass or acrylic structures that ultimately become holographic plates (or architectural windows).



This methodology for Habitat 44° can be described as transparent material representing the *faktura*; the organization of transparent material for its use as a holographic object or as the primary material in a holographic scene that is constructed; and, the emergence of said constructions to be known as “reconstructions” of light through transparent materials. In summary, the Habitat 44° experiments run through a progression of steps that lead to a final constructivist object of light, manipulated via selected transparent materials. In my view, it is the material that becomes the driving force of my experiments as well as the object of focus in my holographic recordings.

To further describe the details of the constructivist art methodology used in the work, the three steps of construction, *faktura*, and tectonics are complemented by the goal of emphasizing *transparency* and *invisibility* in the end result of the constructivist art object. To this end, the object created after the progression of the three major steps is the *spatial canvas*. As the final exhibited object, the *spatial canvas* in my view must possess and speak to the characteristics of transparency and invisibility, whether directly or metaphorically through intellectual production.

## Experimental Architecture

The Habitat 44° pavilion is an experimental structure in pursuit of rethinking the practicality of transparent material for visualizing spatial information and contributing to the infinite dialogue between the physical and the virtual.



Fig. 7. [Frontal View] Habitat 44° pavilion digital sketch

## EXHIBIT

### The Pavilion Experiment

The pavilion experiment is an attempt to design a conceptual pavilion structure made mostly of glass. Then, to fabricate a small physical model of it with clear acrylic. Afterwards, the next stage involves making a hologram of this pavilion concept to be an example of how the medium can be used in architectural practice to visualize designs.

The main objectives of this experiment are to prove that transparent material can be recorded holographically, that reconstructions scale accurately as a virtual image, and that the medium can be used to visualize physical space. To do this successfully, I am trained to make a traditional analog hologram as opposed to a digital hologram which I was first exposed to when working on my previous sculpture *Holomentis*. The main difference for me in this process is getting the hands-on experience illuminating objects and scenes on an optical table, similar to the process of lighting a scene, object or person in a photography setup.

I first create an architectural maquette that consists primarily of transparent material in order to begin a process of construction, the first step in the constructivist art methodology.

1. Fabricate an architectural maquette of my pavilion design.
2. Create a laser transmission hologram of the Habitat 44° pavilion.

Before completing these steps, an essential factor in pursuing this experiment effectively is to set up a few test experiments to educate me on traditional holography processes and confirm the recordability of transparent material of glass and clear acrylic. These test experiments result in a project titled "The Experimental Prototype" which uses an acrylic sculpture as the object of the test and the "Advanced Prototype", a project of an improved maquette but with an identical holographic recording process to the experimental prototype. After the creation of the laser transmission hologram, a design of the coordinated presentation system for both a physical maquette model and a glass plate hologram stand is made.

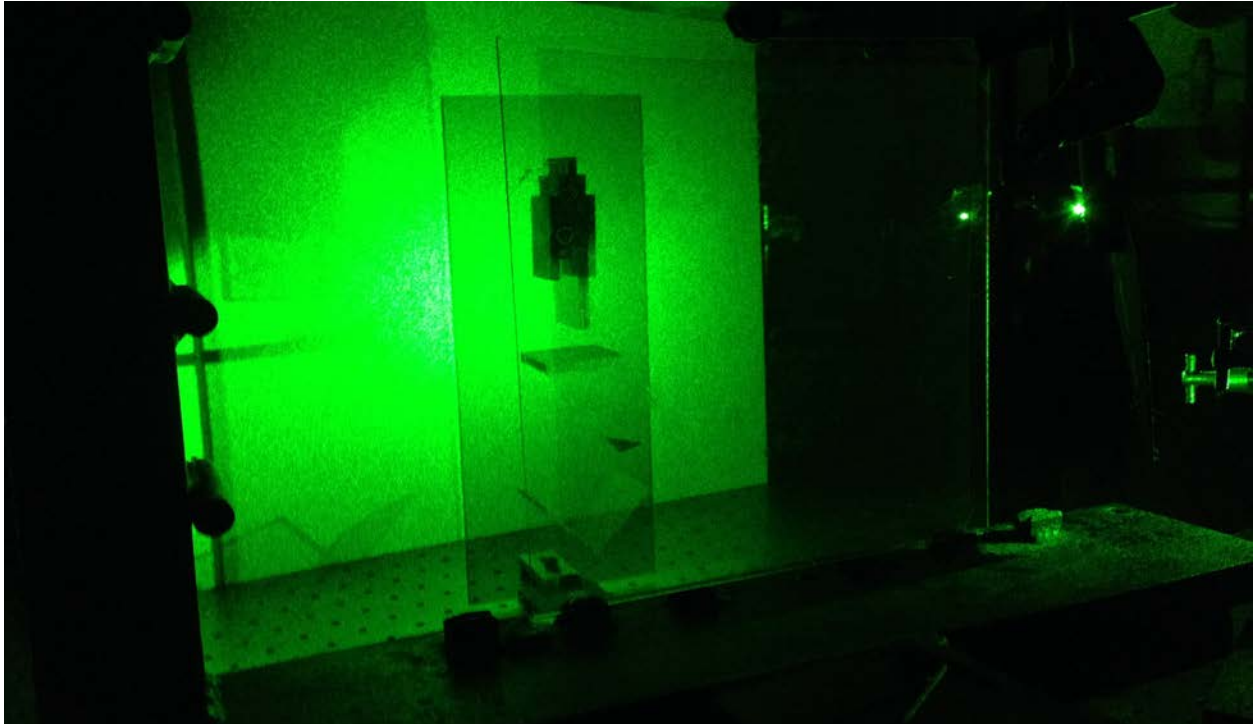

Fig. 8. Photo of acrylic sculpture by Marcus A. Gordon.

## Experimental Prototype

The first experiment involves a cubism-inspired acrylic sculpture. The acrylic colours consist of smoked gray, ruby red, and a burnt yellow. Having consulted with holographers in the lab, it was highly recommended that a significant amount of clear material not be used. As forewarned, the advice centers around the fact that clear material typically does not show well in a hologram, and dark coloured acrylic pieces may simply show as black objects.

The first order of business was to set up the optical table. The components needed for this included:

- A. Laser. In this case, the Coherent Verdi laser was used, which is a green continuous wave laser operating as a single-frequency green at 532 nanometers output.
- B. Beam Splitter. Used to split the laser light into two: an object beam and a reference beam.
- C. Mirrors. A network of mirrors from beam splitters to dichroic mirrors used to align and bounce beams as needed.
- D. Spatial Filter. This device establishes spatial coherence by light that is uni-directional and is designed to expand the reference beam and focus it onto the *holographic plate*. It removes light scattered by dust particles and usually consists of a microscope objective, pinhole and x/y micrometers.
- E. *Holographic Plate*. Where on the optical table the glass plate with holographic film is located.
- F. Diffusers. Small treated blocks of glass used to diffuse the light from the object beam.

These basic components were laid out on the optical table to begin laser illumination tests. A five, ten, and fifteen second exposure of the sculpture was taken, to ensure we can get an idea of a good potential exposure. The manual exposure test revealed the ten second time frame worked best. This was now an approximate target time frame for the recording. The target time frame at this stage is only used as a foundation to work from. This time frame can experience change as different exposures are tried in practice to get near perfect illumination of objects on the optical table. The process for the holographic recording follows a series of steps beginning with the shining of the laser to the beam splitter. The splitter splits the coherent light in two, creating both an object beam and reference beam. The reference beam is the light source that creates the actual holographic recording, it is also known as the recording beam. After the beam splitter creates this beam, it is projected through a spatial filter

which expands the beam to cover the surface area of the *holographic plate*. This plate (normally glass) contains the holographic film, and in this case, is a photopolymer based film. The object beam created by the beam splitter is reflected through a network of mirrors to a set of diffusers that expand and soften the light onto the object. The object, residing in the middle of the optical table, can be viewed from the normal position in front of where the plate would be, giving the holographer a glimpse of how the object will be illuminated, which in turn will be what the hologram will look like when recorded.

When the holographer feels the illumination is just right, the recording onto film begins by closing the laser shutter, turning off all lights leaving only a safe light on. Then, setting up the photosensitive film plate onto the plate holder. The goal at this point is to take a break to allow both the object and the plate to settle in their positions to remove creep<sup>7</sup>. For most objects, this pause time can range anywhere between five to 10 minutes, or even up to 30 minutes for fragile and/or non-rigid objects.

Once the object has been in rest for the appropriate time period, the laser shutter is opened for the suggested time frame, then closed again. Film gets exposed, and now the development process begins. Three trays are prepared to develop the exposed film: a tray of water at room temperature at approximately 20° C, and another tray with RCA (Royal College of Art) developer and another with EDTA (ethylenediaminetetraacetic acid) bleach. The exposed hologram plate is processed into the developer, turning the plate darker to the desired density, which can vary depending on the process. The film is then placed into bleach making the darkened film almost clear again. The chemical process here is turning the silver molecules of the film into a salt crystal material. Then its is placed in water to remove all traces of the bleach. The film is then wet with photo flow and then hung to dry. The development time was set for two minutes in our preliminary tests, which resulted in an adequate soak time for the film to turn dark in the developer.

Once the acrylic sculpture was successfully recorded, the same specifications were used to record the original architectural maquette which was approximately 120 centimetres long at about 30 centimetres in height. It consisted of 18 acrylic panels ranging anywhere from four to 15 centimetres in width. The clear acrylic used here was three millimetres thick which made its overall size a fragile ordeal. The gluing of this maquette was done with a methylene chloride (also known as dichloromethane, CH<sub>2</sub>Cl<sub>2</sub>)

plastic adhesive. It is a water thin, quick air-dry solvent welding compound, the same formula used for the Cubist sculptures recorded in my first tests. Having used a very small paintbrush with the gluing of the sculptures, for the maquette, I experimented with a 0.5 millimetre thick syringe, to maximize accuracy and cleanliness of the welding compound application.

As an additional test for illumination of the maquette, the model was placed on a platform of styrofoam, beside another styrofoam backing. Mirrors, diffusers and the spatial filter were adjusted accordingly for this model prior to recording. Once the illumination was set to its best arrangement, it was clear that the hologram would reveal only *bokeh* style light leaks in the clear acrylic, as opposed to providing a clear view of the acrylic maquette itself. This presented difficulty in seeing dimensionality of the recorded image or scene, defeating the purpose of the hologram. The image, however, was still recorded for my research purposes of educating myself on the challenges of transparent material, but now a new challenge presented itself and needed to be solved.

## Advanced Prototype

Due to this new challenge that came about in the experimental prototype, two things were considered:

1. Can simple changes to the optical table setup with additional objects to the scene create a better view of the maquette?
2. Does another maquette need to be made that would clearly provide a more defined and robust image by making slight changes to the fabrication of the model itself?

Both of these considerations seem like realistic solutions to the problem, however, the first option suggests plenty of trial and error, whereas the second option of fabricating another model was a more structured and time controlled option. The second option also, for the purposes of the thesis research, was a more valuable initiative that would speak best to the conditions of future fabrication of holographic objects.

To complement this new test, the original roofing piece of acrylic cut for the first maquette was used to create an outlined shape on a block of wood. This shape acted as a guide for new pieces of cut acrylic

to be lined up along its edges. The acrylic pieces this time were approximately 2.5 cm<sup>2</sup> and 6 millimetres thick. The 78 pieces that were used, including one 2.5 cm<sup>2</sup> mirror that was placed on the south side of the model, were hot glued to the wood base. The solvent, however, was used to join the rooftop to those pieces. Model making trees were also added to the wood base acting as the landscape to the surroundings of the maquette. This became the improved model to be used on the optical table.

Keeping most of the optical table settings from the previous experiment, the only change included a microscope objective of 8x instead of the 4x used before in the spatial filter and mirror alignment changes to illuminate a new model height. Clearly, after this illumination setup, the view was significantly better and more detailed. The key factors were due mostly to the wood base, smaller acrylic pieces and the landscape objects' height ratio to the height of the model.

#### Result: Construction

The hologram of the maquette was a success after trial and error in the construction phase of the process. The challenge was mostly about proper illumination of the object on the optical table, which was resolved when taking a different approach in the fabrication of the architectural maquette.

#### Result: Faktura

The transparent material was successfully recorded in this experiment as the properties of invisibility were well demonstrated by seeing through the building walls in the maquette, as well as the hologram.

#### Result: Tectonics

Based on the concept of the holograms' use as an architectural tool, was also a success as observations of its scale were an accurate display of the maquette's physical scale. In addition, the viewer also had the ability to change their angle of view of the scene accordingly to the recorded geometry of the physical space of the maquette.





Fig. 9. Photo of *bokeh* effect showing in the illumination of the first maquette by Marcus A. Gordon.

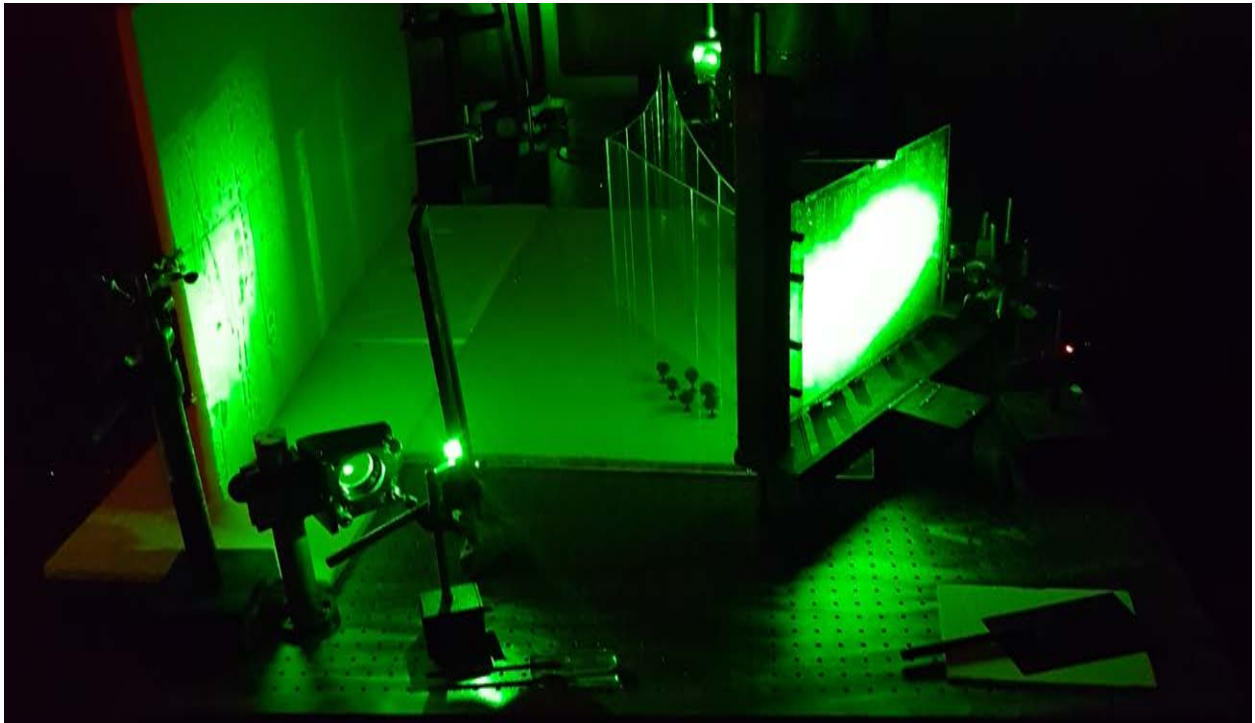

Fig. 10. Photo of optical table setup for the first maquette by Marcus A. Gordon.

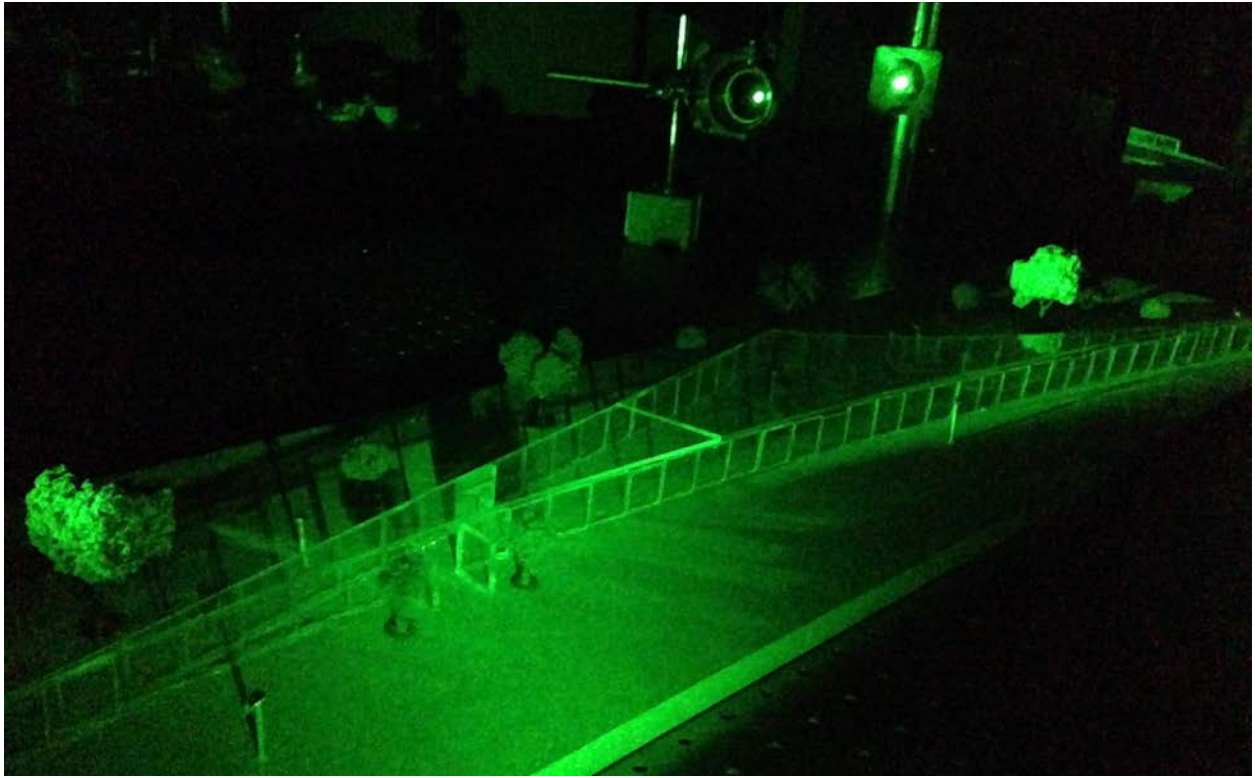

Fig. 11. Photo of the illumination of the second maquette by Marcus A. Gordon.

## The *Spatial Canvas* Experiment

This experiment's objective is to record a non-representational image whose purpose is to allow the virtual to blend with the physical. In this experiment, the non-representational hologram is made to be integrated with the architectural maquette from the pavilion experiment.

The glass window is just one of many architectural elements that can demonstrate and deliver the experience of an extended physical space. As a final phase of experiments, I focus on the architectural window as the vehicle of delivery of such an experience. The importance of the previous experiments are to practice the two steps that I will engage in when making environmental holograms: (1) testing illumination of a conceived object or scene for holographic recording, (2) creating a hologram either for white light transmission or laser light transmission reconstruction to be integrated into architectural space.

This experiment is essentially an exercise in creating a quasi-architectural object, with a planocentric transparent surface, what I call a *spatial canvas*. It refers to the virtual image one experiences viewing a holographic plate and witnessing the depth of a three-dimensional object or scene. A proverbial *memory window* as referred to by Andrew Pepper can easily be considered the *spatial canvas* I make in this experiment. However, the *spatial canvas* goes beyond that, and mostly refers to *subcreation* or *worldbuilding*<sup>8</sup> (Wolf, 2014). This favours less about the past and focuses on the design and abstract conception of a future, similar to the notion of architectural design practice.

The subject of the hologram in this case will be an abstract visual that demonstrates the capability for a hologram to depict sufficient depth and scene lighting. More importantly, the experiment simply seeks to consider the *spatial canvas* as a visualization object of the virtual to be placed into architectural space. To focus on this aspect, I choose to make the hologram non-pictorial to remove any distracting connection of the holographic content itself and place focus instead on the characteristics of holography placed into the context of architecture. As a beginning point to my practice, this is the goal of the hologram's content. In future, the hologram content will likely be justified in the context of their site.

The white light hologram is metaphorically the overall objective of my claim for environmental holography *meeting* architecture, mostly due to the power of the sun and surrounding lights within an urban landscape. However, the characteristics of coherent light make the laser lit hologram the end result choice of my experiment. The rationale behind this is due to the concept of depth. Coherent light travels longer distances than white light, and as such, illuminates a subject or a scene with great appearance of occlusion, distance and significant detail of material texture. It is all of these factors that display the strong depth-perception of a spatial image that is less apparent with only white light reconstruction.

Just as the previous experiments were executed, the optical setup for the spatial canvas hologram included a recording angle of 45°, a spatial filter consisting of the 10x microscope objective and exposed for only four seconds under green laser light. The contents of this hologram used for the *spatial canvas* are small tempered glass objects placed on a black metallic surface. The black metallic block is placed on a black fabric material on the optical table. The purpose of this construction is to level the blocks into a seemingly void space. The blocks are arranged in a series along the metal block in a linear fashion away from the holographic plate, in order to demonstrate the concept of depth beyond the glass surface. With the holographic plate at a dimension of 30 x 40 centimetre arranged in portrait orientation, the recorded hologram shows an odd view of the eight blocks set up from an angled perspective allowing, all of the blocks to be identified by the viewer.

The *faktura* factor is seen through the strong illumination of the tempered glass by direct laser light received through a secondary beam splitter. This splitter is arranged to illuminate the series in two sections of the scene: four blocks closer to the front the plate, and another four farther away from the plate. As the viewer moves left to right or right to left, the two section separation of the blocks become more or less apparent. This observation reinforces the depth perception of the hologram, allowing the viewer to see objects up close and farther away, at will, with their own movements around the plate.

For the purposes of the reconstruction, the fabrication of the *spatial canvas* also consists of a presentation frame holding the holographic plate. During reconstruction tests, the laser beam lighting the plate was expanded with two double convex lenses similar to the ones used in the initial experiment. With a distance not much more than a few centimetres apart from each other, the lenses

are tuned to envelop the holographic plate with laser light. The distance of the beam leaving the second lens and towards the plate is no more than 50 centimetres, just enough to completely illuminate the 30 x 40 centimetre glass. This distance is taken into consideration to fabricate the constructivist art object in the form of a suspended model, complete with optical lenses, solid-state laser and glass plate. The end result is a hologram capable of being situated into an architectural façade as a *spatial canvas*.

As a standalone, the fabricated hologram is a model for a source of light that can be used in any scene. The characteristics of the recorded objects in the hologram also act as *holographic optical elements*, which in the staged orientation to which they were placed on the optical table for recording, acted both as *illuminated* and *illuminating* objects. This duality at play where the objects themselves become mechanisms in the recording process of the scene also speaks to the spatial advantages of recording transparent material holographically.

#### Result: Construction

The layout of the glass blocks allows for a linear view of them that also changes with the viewing angle of the observer.

#### Result: Faktura

The texture of the tempered glass in the blocks not only created a beautiful illumination in the recording process but also made the objects become *holographic optical elements* that aided in the overall illumination of the scene.

#### Result: Tectonics

As a final presentation, the *spatial canvas* is placed in front of both the architectural maquette and its hologram. This demonstrates my overall goal of presenting the virtual image of a hologram with the physical maquette existing in one scene. The changed angle of view of the observers allows for the both holograms and maquette to be viewed either individually or in combination with each other. The

result is a successful experiment that sets the tone for the practicality of a *spatial canvas* and its usefulness of integrating the virtual and the physical.



Fig. 12. Photo of the illumination of glass *holographic optical elements* blocks by Marcus A. Gordon.

Notes

---

<sup>7</sup> Creep is defined as a slow movement, especially at a steady but almost imperceptible pace.

<sup>8</sup> This refers to the idea of the hologram being capable of (measurable and to scale) representation of objects or scenes from another physical "world" that innately is virtual. As opposed to our current world which is one that is tangible; the physical that we can touch.

"The abstract field...a field of hands-on exploration and experimentation. New form is not conceived. It is coaxed out, flushed from its virtuality."

Brian Massumi in *Sensing the Virtual. Building the insensible.* (Massumi, 1998)



EXHIBIT PLATES



Plate. A. Photo of suspended architectural maquette by Marcus A. Gordon.

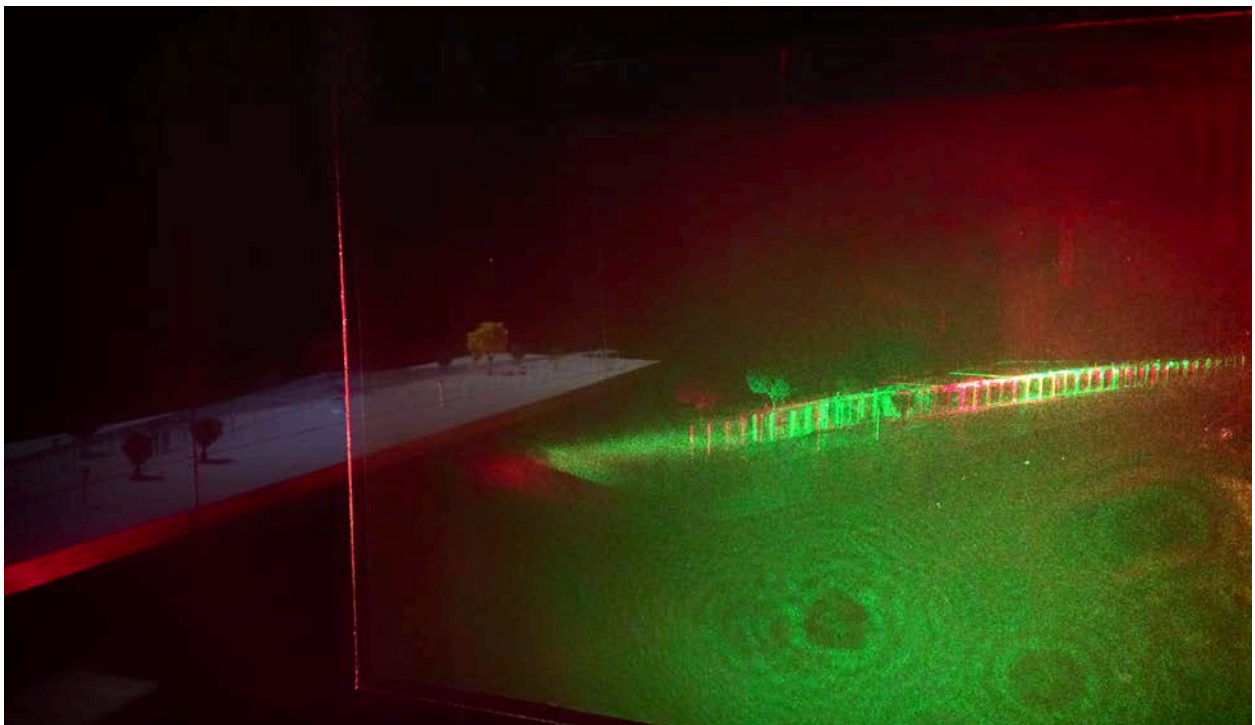

Plate. B. Photo of suspended hologram of architectural maquette by Marcus A. Gordon.



Plate. C. Photo of both exhibited holograms perceived as one virtual image by Marcus A. Gordon.



"Beneath the pavilion's often diminutive canopies are found some rather big ideas about the world."

Joel Robinson *Introducing Pavilions: Big Worlds under Little Tents* (Robinson, 2014)

## CONCLUSION & FUTURE DIRECTIONS

### The Art of Reconstruction

Physical space is what we navigate with our bodies. In summary of the observations from the initial and final experiments, it is to my satisfaction that holographic space is a form of abstraction that can be considered a medium to extend these physical spaces. In the pavilion experiment, the observation of remodeling the maquette with minimal changes to decor and only scaling differences exemplified how dramatic the end result can be from an invisible image riddled with bokeh light leaks to a clear and defined image with visible structure. The spatial canvas experiment demonstrates the duality in transparent material acting as both subject and propagator of light in a virtual scene. These simple yet powerful characteristics of holography are toolkits for reuse in a multitude of other visual artworks I intend to create in my practice.

Massumi stated that “approached topologically, the architect’s raw material is no longer form but deformation” (Massumi, 1998). However, the virtual provides us the capability to massage this deformation with the power of perception, as seen by a viewer’s movement around the glass blocks hologram. This fact also defends my position on holography being a form of virtual that innately is the sculpting of light in three-dimensional space. The final experiment in the making of the constructivist art object, the *spatial canvas*, becomes the vehicle that delivers this form of light sculpture, similar to the artworks that would reside in Krauss’ axiomatic structures field of her diagram. As Krauss describes it, the works in this field are interventions, and holographic artworks although virtual, operate in this “real” space. I conclude therefore that holography is a true “physical” intervention, that in which its viewers’ movements are physical interactions with the spatial image.

So how can the virtual image of holography contribute to the dialogue of abstraction in architecture? Via Massumi’s point of architecture being primarily about the sculpting of spaces of light in the physical realm, holography can act as an augmented physical space and instigate atmospheric change wherever it resides or is situated. Change in depth-perception as observed in the viewing of a *spatial canvas* also contributes to this enhancement, where once there was simply an architectural window to the outside world, is now a window to a virtual world of limitless possibility and measurable transparent

space. In both the pavilion and spatial canvas experiment, the combination of the two do not suggest abstraction of geometric shapes, but instead an operation of abstract logics (Schumacher, 2011, 5.3.1). With a multitude of parameters at play, the virtual image of holography can be compounded, positioned spatially, superimposed, externally illuminated, self-illuminated, reconstructed, and, essentially turned on or off by the viewer by simply changing their angle of view. In addition to the transplanarity of the medium with a transparent material such as glass, the abstraction is further focused or blurred by the interfacing of the physical space in front or behind the glass.

Having successfully reconstructed both holograms in the exhibit with one single green laser beam, the addition of another laser, red, complemented the green. In the arrangement set forth, the red and green glass blocks in the front hologram lined up spatially with the baseline of the hologram of the architectural maquette. As such, the maquette hologram too had a flush linearity of red and green window panes of the building. This continued line brought to bear two important observations: (1) the fact that different wavelengths of light change the overall size of the recorded wavefronts, red and green laser differences were (at least visually to the viewers eyes) very small in our maquette scale, but larger with the glass blocks, and (2) this intersection of wavelengths also contributed to frequent discussions with viewers curious about the duality of the red and green laser colours over the duality of the virtual image and physical object. The linear setup of both the virtual image of the maquette and glass blocks created a spatial continuity amongst the objects, suggesting some sort of infinite depth.

The maquette of the pavilion is placed behind the holograms of the glass blocks and beside the hologram of itself. The importance of this setup is three-fold, having the glass blocks leveled with the ground and landscape of the maquette, displaying a model for virtual and physical integration, and finally a 1:1 scale side by side view of the pavilion's physical and virtual creation. This exhibition has taught me the values of working with the analogue format, including the viewing of virtual three-dimensional space, potentially awaiting digital manipulation. It has brought to light opportunities for integration with projection mapping and other digital lighting techniques. This exhibit, therefore, clearly states the intent of the pieces as models but more specifically a model of representation systems working together as one unit. The result here is a *model* of a large scale representation.

## Future Directions: Augmented Reality

Observing first hand that the hologram can virtually and measurably occupy physical space, this observation also leads to the idea that holography is a form of augmented reality that is *autostereoscopic*. As opposed to only using current 3D digital augmented reality technology, augmenting a scene with 3D holography allows any viewer to experience the augmentation without special glasses or other technologies between themselves and the subject or scene. As such, I will continue to maintain that the use of the holographic medium in my art practice will also act as a foundation for media architecture interventions that can be further augmented with digital technology.

As a model of analogue and holographic representation, Habitat 44° demonstrates a capable manifestation of abstract systems through spatial modeling. The mixture of the virtual images of the holograms superimposed and juxtaposed to the physical architectural model not only creates a hybrid optical space but a multimodal dialogue in that space as well. My curiosity in using this complex interaction as a basis for further digital augmentation is still elementary. Interested in the applications of augmented reality (AR) to these spatial models, it is without a doubt just a starting point in which holography can contribute to the transformation of architectural spaces. AR has its own dialogue in which two approaches to the technology lead its linear growth: (1) one that focuses on the augmentation of the built environment itself, and (2) the other which places an overlay of transparent media surface between us and our environment (Cowling, 2016). The first approach suggests the use of physical computing and IoT (Internet of Things) technology that essentially creates a "smart city", and the second approach uses digital transparent screen technology to inform our eyes directly with information mixed with the physical things we see around us. Whichever of these approaches is used, the holographic medium creates opportunities for virtual markers in AR or permanent spatial information that match with a physical attribute of the space. The holography and augmented reality hybrid possibility are what I consider to be the first contingent for my practice onwards.

## Future Directions: Material Energy of Light

To conclude with this future direction of the research is to return to the inspiration behind a much bigger idea. The inspiration was driven by the idea of light being the current shift in means of computation, such that digital technology can be processed at the speed of light. I began to wonder what this could mean for many different things, but studying holography and having this ever growing desire to work with architectural spaces led me to imagine how a metropolitan city would change to accommodate this shift. It was from this thinking that pushed me in the direction of investigating transparent material, media architecture, and the parametricism of light. There is only one medium that scientifically proved the capability of freezing light in physical space in the manner in which I am trying to imagine it: that is holography.

In Sean Lally's book "The Air from Other Planets," he defines amplification as a strategy that intensifies and builds upon the existing properties of a known condition, accentuating them until the condition becomes something other than itself. Producing architecture through amplification involves strengthening the energies associated with exterior *microclimates* until they become a material to build with (Lally, 2013). When my world building professors introduced me to the writings on digital architecture from Brian Massumi and futurist architecture research of Sean Lally, the connection for Habitat 44° was made. The big research question of all was: *Could holographic light be a material energy in Lally's vision?*

In Lally's view, the architect is not much different from the explorer. It is the architects' imagination that pushes to explore terrains, perspectives, and materials, to conceptualize their creations. Lally's outlook explores the idea that architects should look to the use of *material energies* as new building blocks. The experiments of Habitat 44° contributes to this idea, such that the *spatial canvas* becomes a *microclimate* in which light structures are formed. Light as *material energy*, in my view, is manifested through the medium of holography, creating an expressive form of architectural representation and construction.

## REFERENCES

- Bertol, D., & Foell, D. (1997). *Designing digital space: an architect's guide to virtual reality*. John Wiley & Sons.
- Colomina, B. (1992). *Sexuality and Space: Princeton Papers on Architecture*.
- Cowling, M., Tanenbaum, J., Birt, J., & Tanenbaum, K. (2016). Augmenting reality for augmented reality. *interactions*, 24(1), 42-45.
- Dawson, P. (2011). *The Visual Language of Holograms*. INTECH Open Access Publisher.
- Esche, C., & Bradley, W. (Eds.). (2007). *Art and social change: A critical reader*. Tate Publishing.
- Gabor, D. (1949, July). Microscopy by reconstructed wave-fronts. In *Proceedings of the Royal Society of London A: Mathematical, Physical and Engineering Sciences* (Vol. 197, No. 1051, pp. 454-487). The Royal Society.
- Gough, M. (2005). *The artist as producer: Russian constructivism in revolution*. Univ of California Press.
- Hockett, P., & Ingleby, T. (2016). Augmented Reality with Hololens: Experiential Architectures Embedded in the Real World. *arXiv preprint arXiv:1610.04281*.
- Krauss, R., Bois, Y. A., Buchloh, B. H., Foster, H., Eigen, E., Kwon, M., ... & Allen, S. (2014). *Retracing the expanded field: Encounters between art and architecture*. S. Papapetros, & J. Rose (Eds.). Cambridge, MA: MIT Press.
- Krauss, R. (1979). Sculpture in the expanded field. *October*, 8, 31-44.
- Lally, S. (2013). *Air from Other Planets: A Brief History of Architecture to Come*. Lars Muller Publishers.
- Massumi, B. (1998). Sensing the virtual, building the insensible. *Architectural design*, 68, 16- 25.
- Pepper, A. (1989). Holographic Space: a generalised graphic definition. *Leonardo* (1989), 295-298.
- Poissant, L. & Nelson, L. (2001). New Media Dictionary: Part IV: Holography. *Leonardo* 34(4), 370-380.
- Robinson, J. (2014). Introducing Pavilions: Big Worlds under Little Tents. *Open Arts Journal*, 2, 1-22.



Rowell, M. (1978). Vladimir Tatlin: Form/Faktura. *October*, 7, 83-108.

Saxby, G. (2003). *Practical holography*. CRC Press.

Schröter, J. (2014). *3D: History, Theory and Aesthetics of the Transplane Image*. Bloomsbury Publishing USA.

Schumacher, P. (2011). *The Autopoiesis of Architecture: a new framework for Architecture* (Vol. 1). John Wiley & Sons.

Wigley, M. (1998). *Constant's New Babylon: the hyper-architecture of desire*. 010 Publishers.

Wolf, M. J. (2014). *Building imaginary worlds: The theory and history of subcreation*. Routledge.

## APPENDIX A: GLOSSARY

*Autostereoscopic* means relating to or denoting two-dimensional images that may be perceived as three-dimensional without the need for special optical equipment. (New Oxford American Dictionary)

*Axiomatic Structures* "whatever the medium employed, the possibility explored in this category is a process of mapping the axiomatic features of the architectural experience - the abstract conditions of openness and closure - onto the reality of a given space." (Krauss, 1979)

*Bokeh* is the visual quality of the out-of-focus areas of a photographic image, especially as rendered by a particular lens. (New Oxford American Dictionary)

*Computational Photography* refers to the processing of photographic images into a sequence for the purposes of generating spatial information on a subject or scene.

*Environmental Holography* is public holographic art (murals, holosculptures, multimedia works) permanently integrated into architecture or an environment. Because of its visual aspect and spatial presence, environmental holography can

be considered a holographic installation. (Poissant, 2001)

*Faktura* is the expression of material structures (that includes the process of its creation and use) (Gough, 2005).

*Holographic Space* is the virtual space in front of and behind a *holographic plate*, which is where on the optical table the glass plate with holographic film is located.

*Holographic Installation* is an artwork based mainly on the integration of holographic images within a given space so that they are not the only formal vehicles that give meaning to the piece and spectators can stroll among them. (Poissant, 2001)

*Holographic Optical Elements* is a holographic optical component that can be used in place of lenses, mirrors, collimators or other optical components in the reproduction of recorded light information. (Poissant, 2001)

*Isomorphic* corresponding or similar in form and relations. (New Oxford American Dictionary)

*Material Energies* are intensified versions of the energies already around us (electromagnetic,

thermodynamic, acoustic and chemical). Material energies are the stimuli and information within our surrounding context that the human body can perceive. (Lally, 2013)

*Microclimate* represents the climate of a very small or restricted area, especially when this differs from the climate of the surrounding area. (Lally, 2013)

*Necessary Form* "Tatlin's 'necessary form' is a compound logic; it was to express truth to materials, mankind's authentic creative will, the universal laws of human experience, and a social necessity." (Rowell, 1978)

*Quasi-architecture* is architectural artworks and structural objects that are described to be somewhere between the characteristics of sculpture and architecture.

*Reflection Hologram* is a monochromatic or multicolored hologram that must be lit by a frontal and directional white light (at about 45°) so that the recorded image can be reconstructed by the selective reflection of certain light frequencies from the light-sensitive emulsion. (Poissant, 2001)

*Spatial Canvas* is a term I use to describe a transparent surface in a physical space

subjected to holographic intervention and displays a virtual image behind this surface.

*Theater Box (or Loge)* is a private box or enclosure in a theater. (New Oxford American Dictionary)

*Transmission Hologram* is a master or copy hologram in which the image can be viewed when a light source passes through the recording medium, somewhat like a slide. (Poissant, 2001)

*Transplane Image* refers to stereoscopy, photo-sculpture, integral photography, lenticular images, holography; images that provide more information on space or spatial structures of objects (Schröter, 2014).

*Virtual Optics* computer generated optics. Makes other optic modes optional, connecting different optics in ways not possible before. It is also responsible for reviving the sense of touch via interactive images (Schröter, 2014).

*Wave Optics* describes phenomena of light like diffraction, polarization and interference, which geometric optics does not describe. The mathematical formulas of wave optics allowed for Lippman in 1891 to establish interferential colour photography and for Gabor to lay the

foundations for holography in 1948 (Schröter, 2014).

*Wavefront* is the surface of a propagated wave in which the wave phase is uniform throughout. A wave that originates from a point of light has a spherical front. A collimated beam has a plane front. In holography, a reflected wave, such as an object wave or a wave that is intercepted by an object of varying shapes, has a complex wavefront. (Poissant, 2001)

## APPENDIX B: HOLOGRAPHY SPECIFICATIONS

### Optical Table Setup (Advanced Prototype)

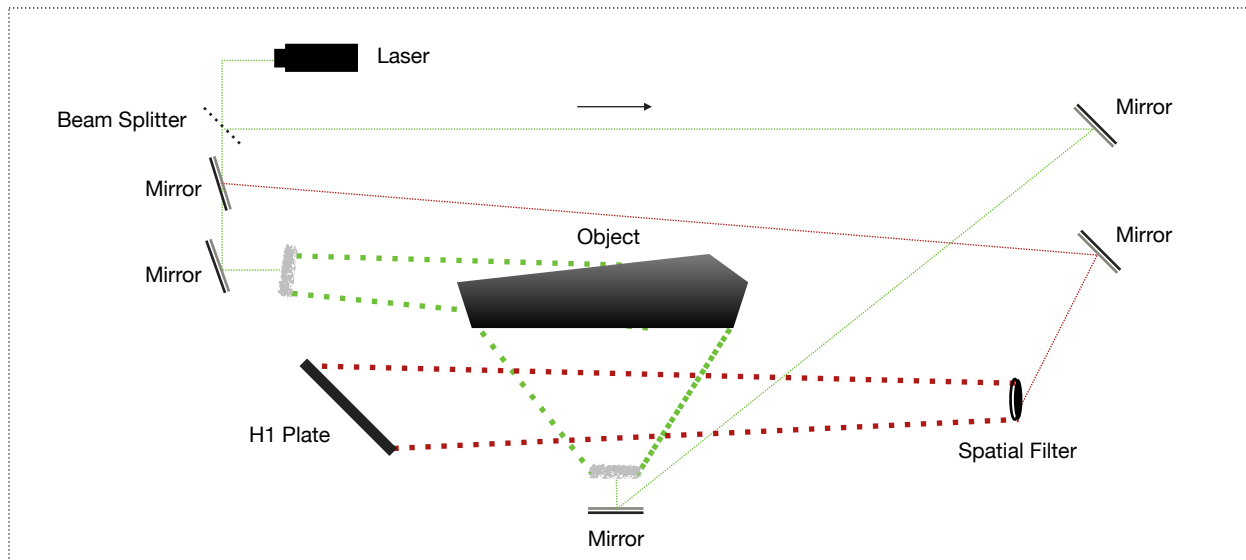

Diagram. B1. Diagram of optical table setup for the Advanced Prototype by Marcus A. Gordon.

### The Chemistry

Before beginning the advanced prototype, there was a need to create new developer solution to replenish from past experiments. This presented a great opportunity to learn the basics of creating the standard solution used at the OCAD University PHASE Lab.

After a *holographic plate* is exposed to laser light, it is then placed in a light safe box to travel to a darkroom for development. The developer formula used by the lab was created by Nick Phillips for the Royal College of Art, hence the formulas' nickname RCA developer. As an amendment to the common D-19b formula used in film photography, the RCA developer has a few distinctions from the original D-19b formula: (1) it does not use metol or potassium bromide in its solution, and (2) uses phenidone (Saxby, 2003). Along with a few variations in the portions of these ingredients, the recipe also has an overall emulsion speed that is doubled compared to its D-19b parent. Here's the recipe list:

**RCA Developer**

Sodium Sulphite 30g

Hydroquinone 8g

Sodium carbonate 60g

Phenidone 2g (alcohol is added to this first, until dissolved)

These amounts are then diluted in 1L water.

For the bleaching agent, the lab uses what is called EDTA, ethylenediaminetetracetic acid. Its formula is as follows:

**EDTA (bleaching agent)**

EDTA disodium salt 30g

Ferric sulfate 30g

Potassium bromide 30g

This is then mixed to 1L of water.

Optical Table Setup (*Spatial Canvas*)

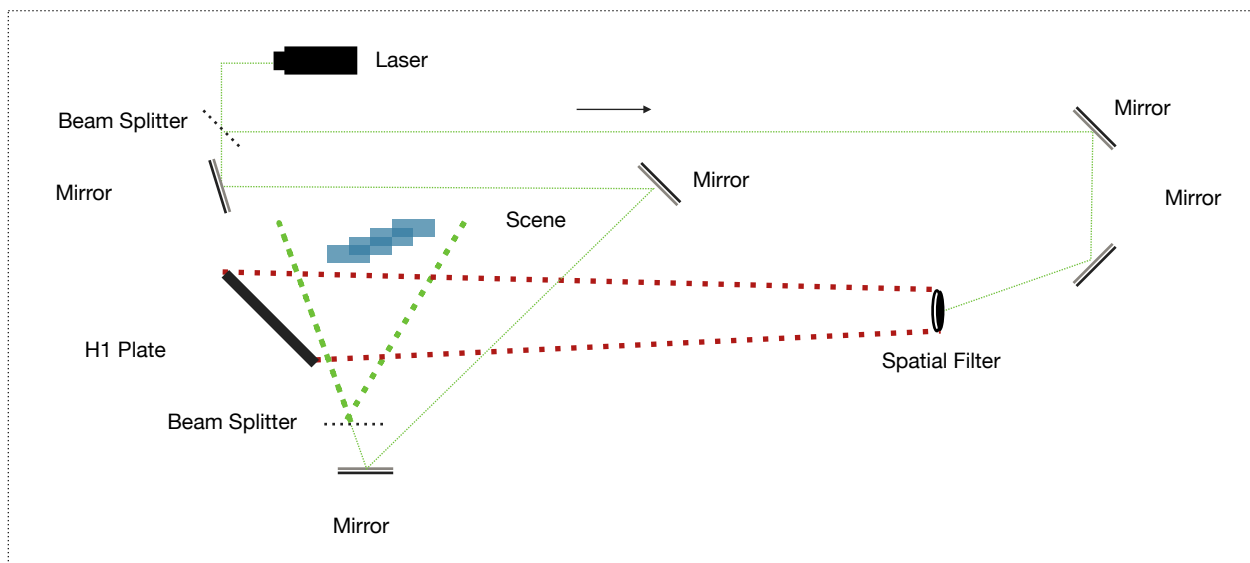
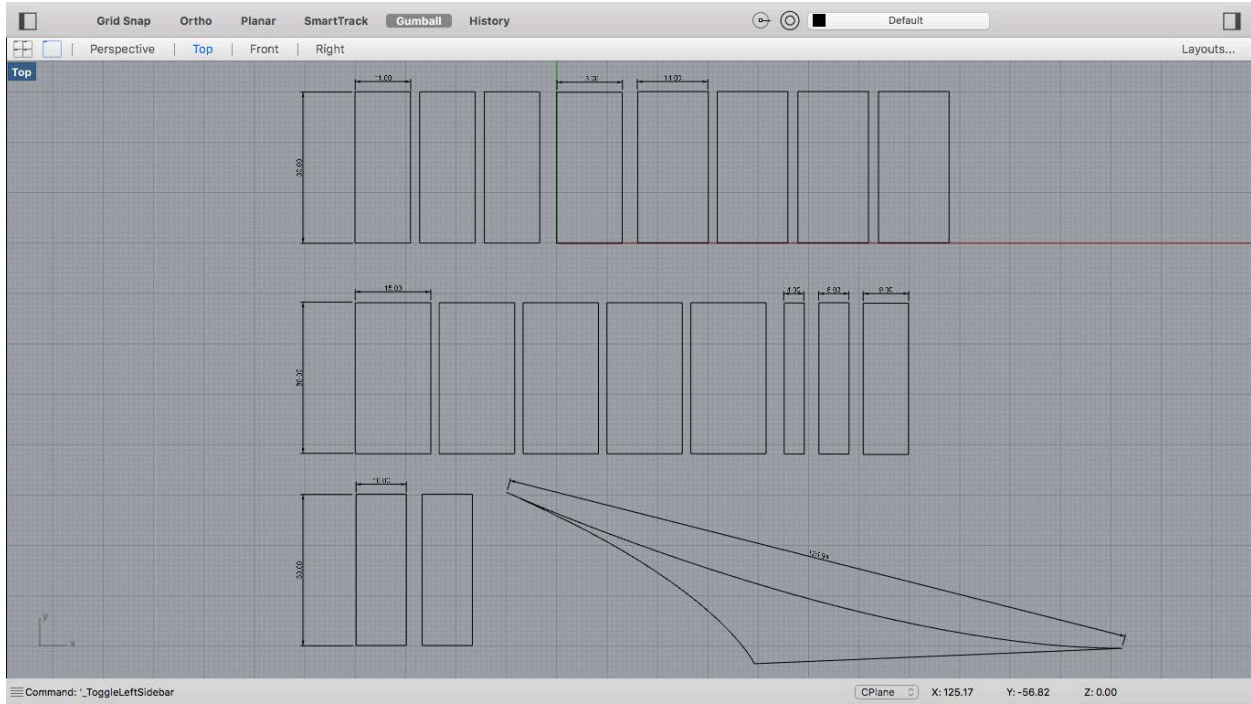
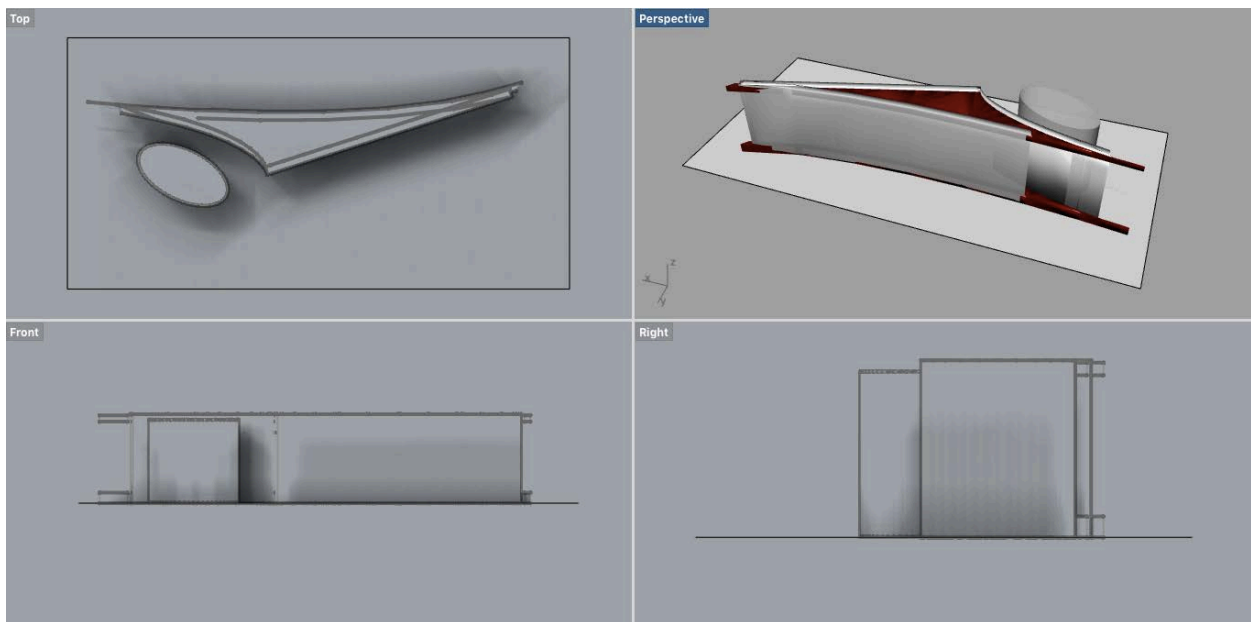

Diagram. B2. Diagram of optical table setup for the recording of the *Spatial Canvas* by Marcus A. Gordon

## APPENDIX C: DIGITAL SKETCHES & DRAWINGS



Sketch. C1. Building blocks of the Experimental Prototype by Marcus A. Gordon.



Sketch. C2. Original model of Habitat 44° pavilion concept by Marcus A. Gordon.

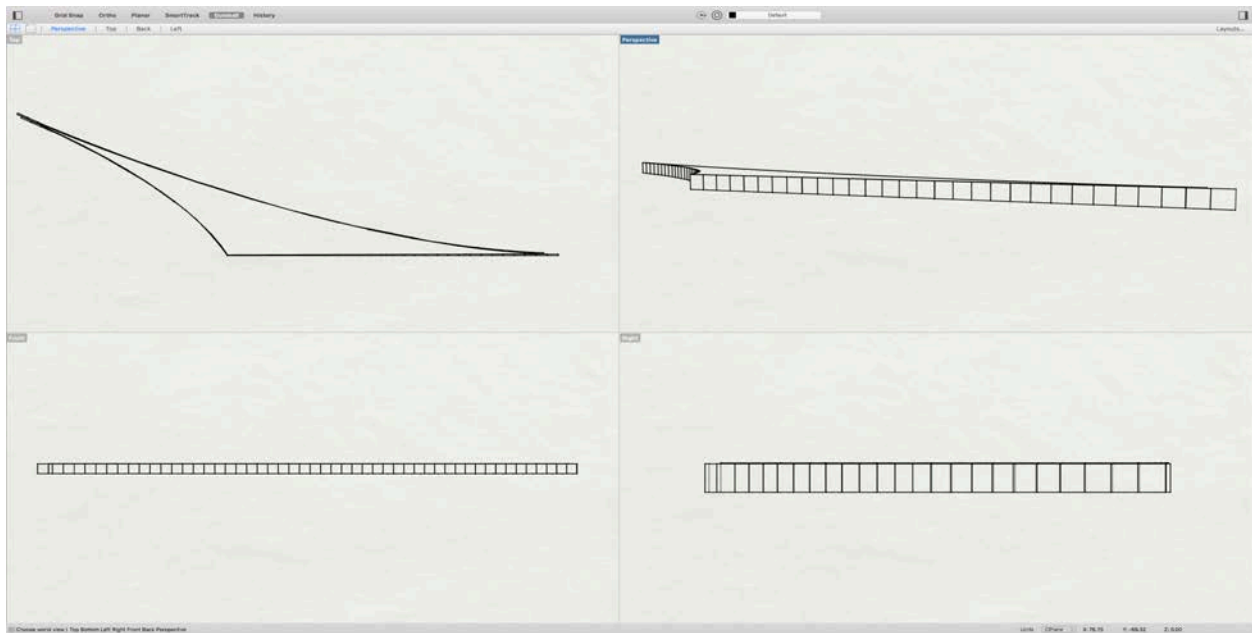

Sketch. C3. Digital sketch of architectural maquette by Marcus A. Gordon.

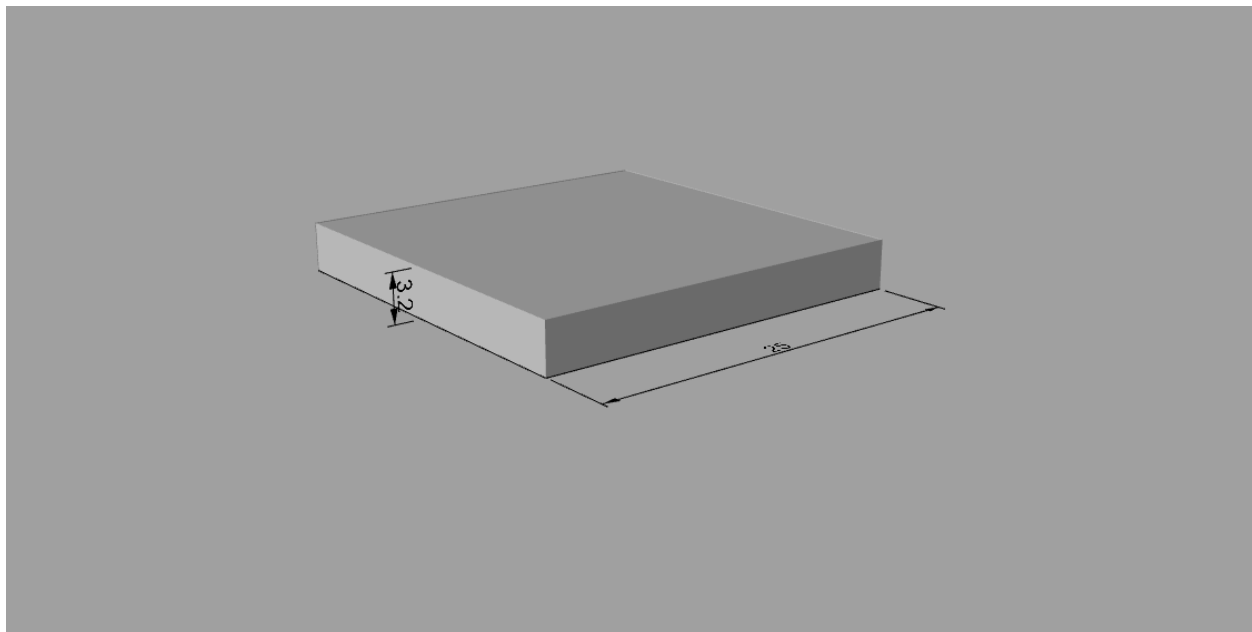

Sketch. C4. Measurements sketch for maquette windows by Marcus A. Gordon.



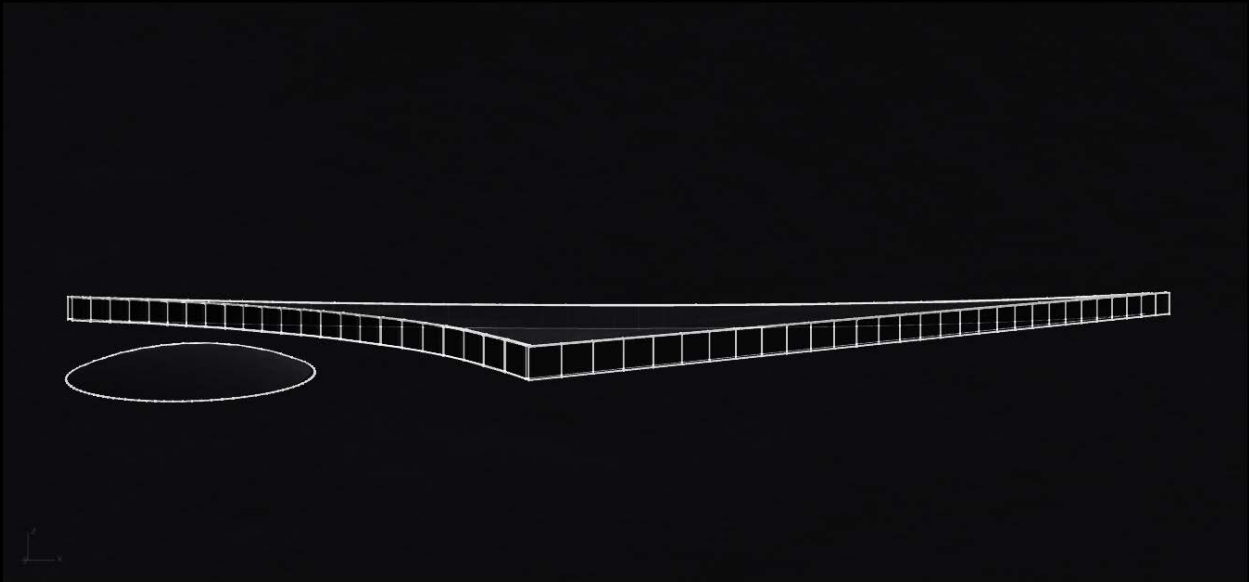

Sketch. C5. Habitat 44° pavilion concept with geodesic dome by Marcus A. Gordon.

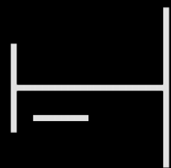

© Marcus A. Gordon